

# F3S-TGR-CL SERIES

Safety light curtains



- » Comprehensive body, hand and finger protection
- » **Reliable, versatile, flexible**
- » No software, no programming

# Total consistency – across the board

*All-new Omron F3S-TGR-CL safety light curtains provide comprehensive body, hand and finger protection, making them suitable for the widest possible range of applications in packaging and general industry. F3S-TGR-CL safety light curtains can be configured to suit different applications precisely, yet they are very simple to engineer, install and set-up.*

### Engineered for efficiency

The comprehensive range of F3S-TGR-CL safety light curtains meets Type 2 and Type 4 safety applications, complying with EN 61496 and EN ISO 13849-1. There are standard models to suit the majority of applications, with advanced models offering further functionality. And every single unit in the range is designed in exactly the same way. This total consistency saves time at every stage, cutting costs with absolutely no compromise on security.

### Global support on your doorstep

Developed with the benefits of uniquely comprehensive applications expertise, F3S-TGR-CL safety light curtains are available across Europe on short lead times. Omron engineers can advise on precisely the right configuration for your application, working with your team to ensure total security. And wherever your machine is used, Omron's local network will provide post-installation support and advice. It's a package for total peace-of-mind at all times.

### Benefits without compromise

**Specification has never been simpler:** F3S-TGR-CL safety light curtains have the same feature-set across the range, and every model comes with a standard connector and mounting brackets. Both engineering and use are simplified, with cost benefits for you and your customer.

**No programming – ever:** All F3S-TGR-CL safety light curtains are set up in exactly the same way using integrated dip-switches. There are no special tools to use (or lose), no programming to change or update, no menus to translate or adapt. It's safety you just plug-in and use.

**Train once, use many:** Because these safety curtains use the same parameters whatever the application, all staff can be trained once – and once only. Designers rely on the same

features, production engineers use the same layouts, installation technicians use the same set-ups. It's that simple.

### Solutions for safe investment:

F3S-TGR-CL safety light curtains are fully compatible with all previous Omron TGR F3S-TGR-SB safety sensors and work with the full range of Omron TGR safety sensor accessories.

### Consistency in every application

- Consistent ordering, engineering, configuration
- The same design parameters - always
- Global support wherever you are
- Comprehensive range to meet all needs
- EN ISO 13849-1 certified



Finger protection



Hand protection



Body protection

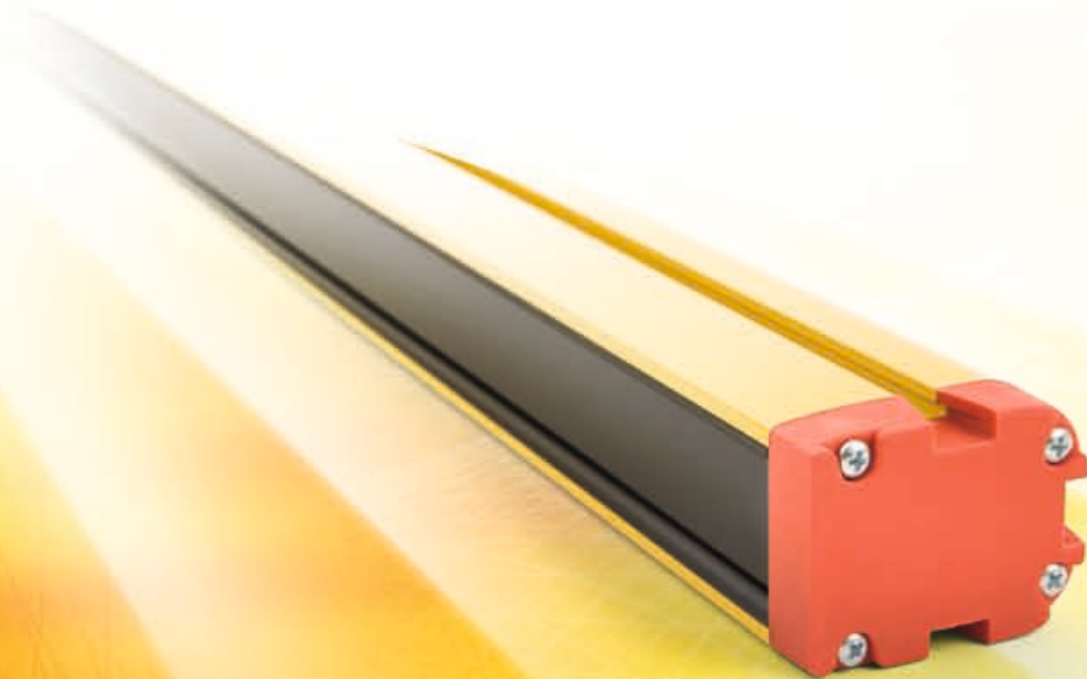
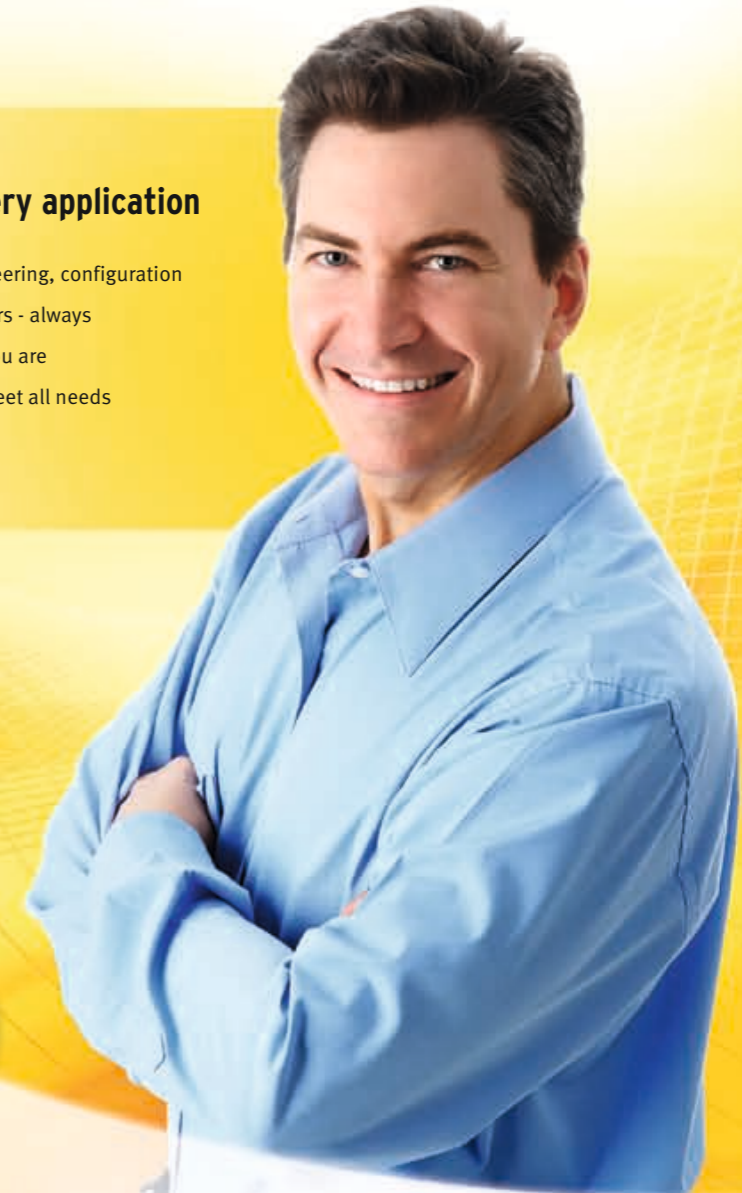

## Versatile muting for broader applications

Automated production systems can be protected using fixed guards, but where material goes in and out of a danger zone, muting can aid efficiency without affecting operator safety. A full range of muting options is available with F3S-TGR-CL safety light curtains using standard Omron accessories. They can be fully integrated so there's no need for standalone muting sensors, while standard connectors and dip-switch set-up means the curtains can be fitted and configured easily.

### Palletiser safety with integrated muting

An F3S-TGR-CL safety system with a muting activator enables automated muting when a package on a conveyor breaks the beams. The F3S-TGR-CL safety system incorporates an active side and a passive reflecting side with pre-installed mirrors. When the package has passed the curtain, the beams are reactivated. Functionality is the same whether used in a Type 2 or Type 4 safety application, in T-, L- or X-shape muting in active-active or active-passive setup.

### Mute to suit your application

With integrated LEDs for alignment, muting and override on every curtain, set-up really could not be simpler. T-, L- and X-shape muting can be selected, depending on the application, so that products on conveyors can be safely moved in and out of dangerous areas. All muting actuators perfectly fit our F3S-TGR-CL safety sensor range. T-, L- and X-shape is available in active-active for long range and active-

passive for short range applications. The integrated muting lamp shows when the muting facility is activated, so that safety is neither compromised – nor complicated.

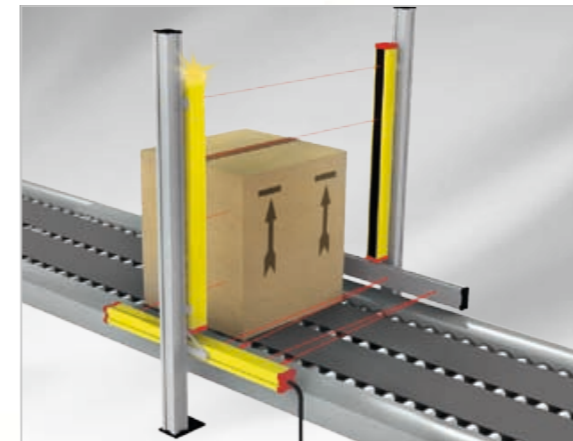

**T-Shape muting:** Bi-directional muting allows reliable detection of boxes passing into and out of the danger-zone. Boxes don't need to be aligned on the conveyor so there are no timing restrictions.

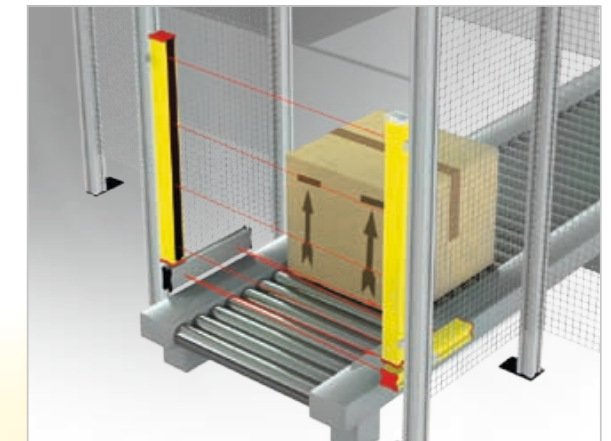

**L-Shape muting:** When materials exit the danger zone, two sensors enable the muting function. Installation time is reduced, and there are no time constraints when boxes are not aligned on the belt.



**X-Shape muting:** If pallets are not evenly packed, or if there are small gaps between the products – for example, on pallets loaded with bottles - time-controlled X-shaped muting will maintain safety without complex installation requirements.

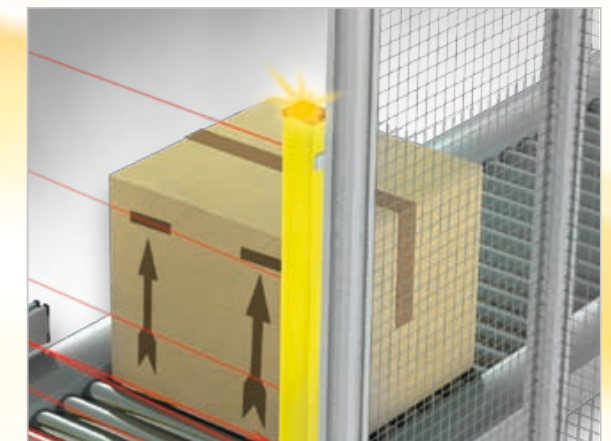

**Integrated muting lamp:** The muting lamp is installed close to the muted section to indicate when muting has been activated, warning operators against entering the danger zone. The integrated lamp means installation is straightforward, while LED technology ensures a long working life.

## Body, hand and finger protection in long- and short-range applications

These safety light curtains are designed for use in the widest range of packaging and industrial applications. Two-, three- and four-beam models give protected heights from 500 to 1200 mm for complete flexibility in machine design. An extended operating range of up to 50 m makes the curtains suitable for full-body protection of operators working with conveyor systems, while 14 mm finger protection can be used for heavy press brakes and similar equipment.

### Automated conveyors

Crossing-stations within automated conveyor systems must be protected so that workers can safely move from one part of a warehouse or production line to the other. With a 50m operating range, F3S-TGR-CL safety light curtains can be used to provide reliable protection, even in environments where visibility is less than perfect.

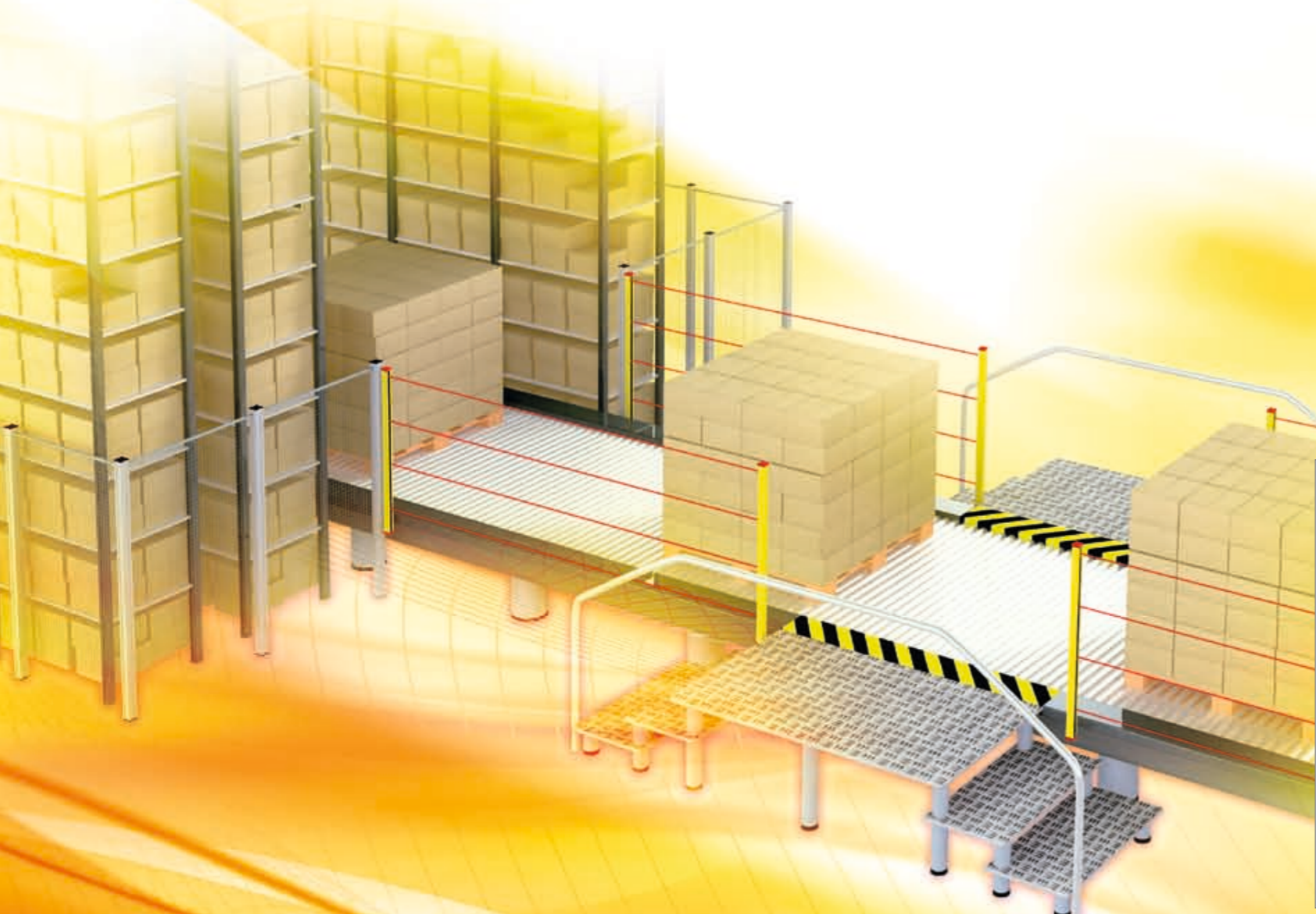

### Press brakes and metal forming

Traditionally, 14 mm resolution safety light curtains are used to provide finger protection at the front of presses, with the back secured by a fixed guard. The Omron F3S-TGR-CL range of curtains can be used on both sides of a press, providing secure and efficient protection, with easy access for the operator: as with all F3S-TGR-CL models, integration is simple because both units use the same installation and mounting

methods. A fully integrated single- and double-break function on the 14 mm and 35 mm models enhances efficiency in various press applications.

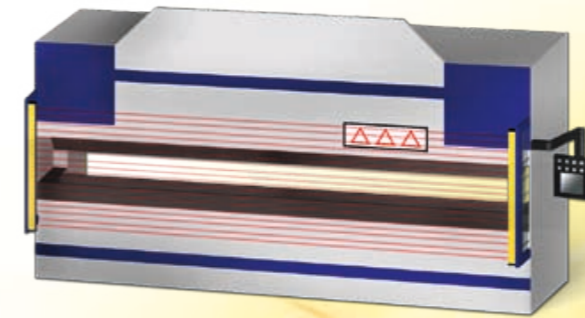

Front using 14 mm finger-protection system

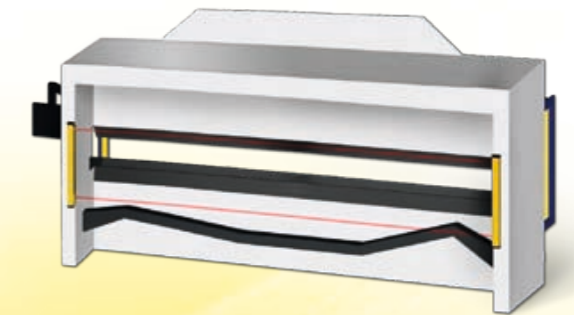

Back with two-beam body-protection system when distance to the danger zone is big enough

### Mounting

F3S-TGR-CL system has three rails for mounting. Standard brackets coming with the product (1) or adjustable mounting brackets as accessories (2) offer flexibility in mounting and adjusting as well as rigidity for minimum maintenance.

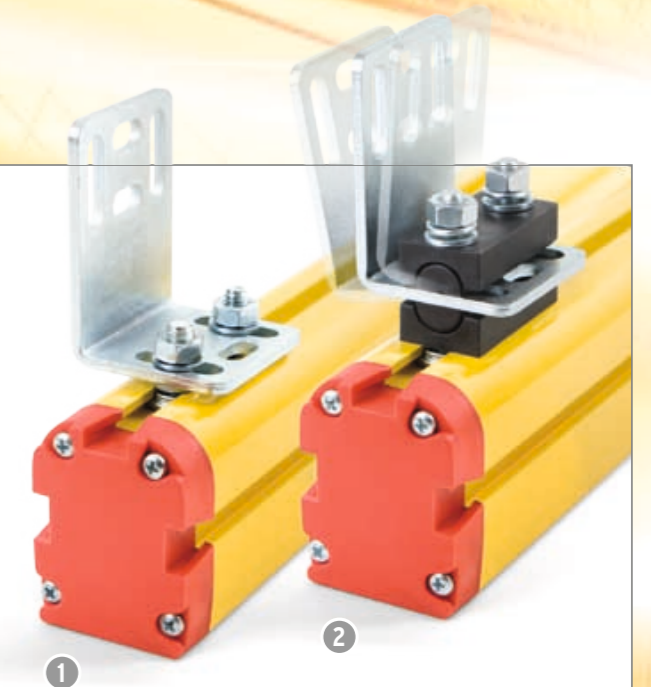

## Special functions for enhanced efficiency

The versatility and simplicity of F3S-TGR-CL safety light curtains makes them suitable for an exceptionally wide range of applications, from simple hand/finger protection on a standalone machine to time-controlled protection of several pieces of equipment within an automated production area. Yet no matter what the application, the same methodology means operatives and maintenance personnel follow exactly the same procedures – in total security.

### Pre-reset

In automated industrial applications, where nesting of machines is common, care needs to be taken when individual machines are started.

Person A in the picture below is clearing the machine after a problem. Person B has already finished work and leaves the section. If Person B now restarts the machine, the situation will be dangerous for Person A since the robot will start moving. Using pre-reset function, a reset of the safety system is only possible by first activating the pre-reset pushbutton (1) before leaving the section (2) and resetting the safety system from outside (3).

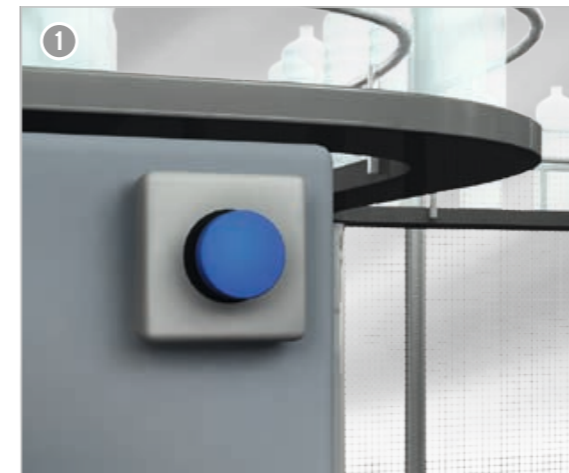

Local pre-reset pushbutton inside the machine that needs to be pressed before the safety system can be reset



Safety light curtain for easy access, for example by a forklift truck



Reset pushbutton to acknowledge and start



### Partial muting

While other systems offer “all or nothing” muting, Omron F3S-TGR-CL models are entirely flexible, allowing just some of the beams to be muted. This can protect operators in applications where products or accessories are changed automatically, such as this roll-changer. A four-beam system is used to protect workers: the three lower beams are muted, the top beam remaining active to protect workers while rolls are moved.

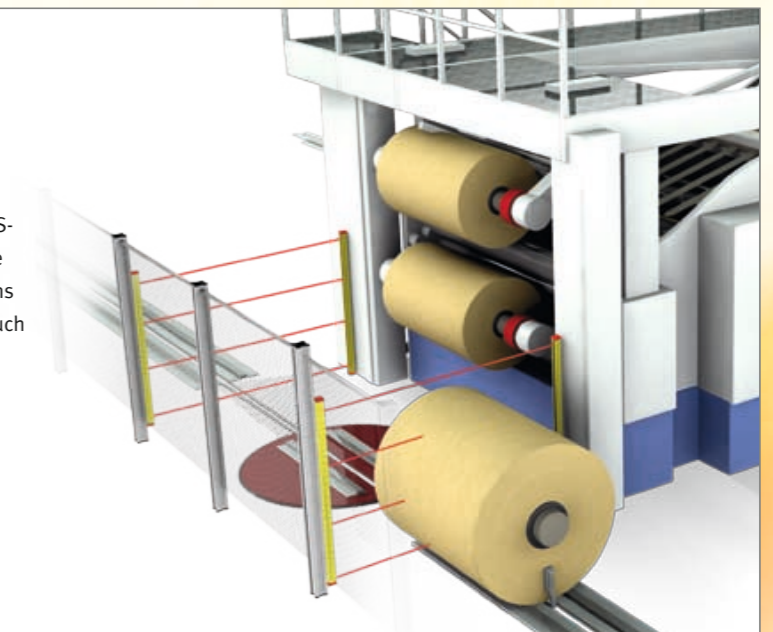

# F3S-TGR-series in five simple steps

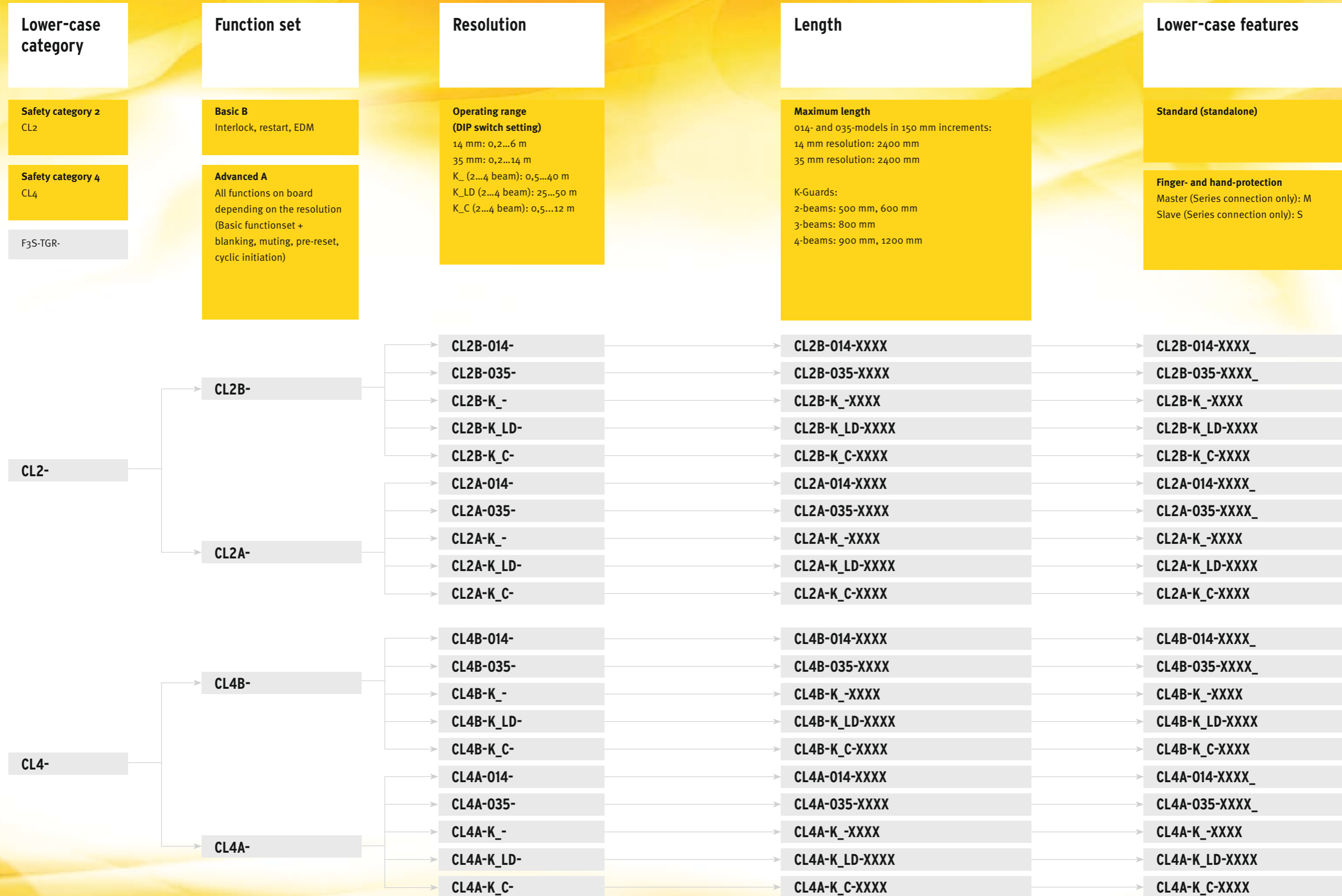

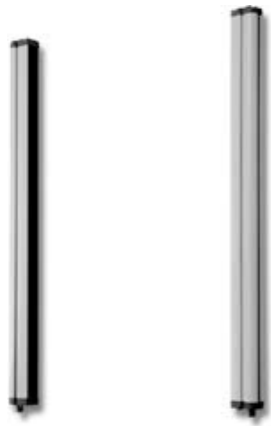

### Multi-beam, finger- and hand protection safety sensor

The multi-beam sensors are available in Category 2 (PL c) and Category 4 (PL e) with integrated muting function. The finger- and hand protection models are available in Category 2 (PL c) and Category 4 (PL e) with integrated safety control functions.

- Type 2/Type 4 sensor complying with EN 61496-1
- Family concept in wiring and mounting

#### Multi-beam models

- Sensing distance up to 50 m
- DIP-switch setup for muting, pre-reset, interlock function and optical coding
- Muting function and muting lamp integrated

#### Finger- and hand protection models

- Sensing distance up to 0.2 m...6 m (14 mm) and 0.2 m...14 m (35 mm)
- DIP-switch setup for blanking, interlock function, muting and optical coding
- Floating blanking and Fixed blanking supported

### Ordering information multi-beam safety sensor

#### Long-range active/active systems

##### F3S-TGR-CL2\_-K\_ (Type 2)

Number of optical axes	Sensing distance	Beam pitch	Feature set*1	Order code
2	0.5 m ... 40 m	500	Advanced	F3S-TGR-CL2A-K2-500
2	0.5 m ... 40 m	500	Basic	F3S-TGR-CL2B-K2-500
3	0.5 m ... 40 m	400	Advanced	F3S-TGR-CL2A-K3-800
3	0.5 m ... 40 m	400	Basic	F3S-TGR-CL2B-K3-800
4	0.5 m ... 40 m	300	Advanced	F3S-TGR-CL2A-K4-900
4	0.5 m ... 40 m	300	Basic	F3S-TGR-CL2B-K4-900
4	0.5 m ... 40 m	400	Advanced	F3S-TGR-CL2A-K4-1200
4	0.5 m ... 40 m	400	Basic	F3S-TGR-CL2B-K4-1200
2	25 m ... 50 m	500	Advanced	F3S-TGR-CL2A-K2-500-LD
2	25 m ... 50 m	500	Basic	F3S-TGR-CL2B-K2-500-LD
3	25 m ... 50 m	400	Advanced	F3S-TGR-CL2A-K3-800-LD
3	25 m ... 50 m	400	Basic	F3S-TGR-CL2B-K3-800-LD
4	25 m ... 50 m	300	Advanced	F3S-TGR-CL2A-K4-900-LD
4	25 m ... 50 m	300	Basic	F3S-TGR-CL2B-K4-900-LD
4	25 m ... 50 m	400	Advanced	F3S-TGR-CL2A-K4-1200-LD
4	25 m ... 50 m	400	Basic	F3S-TGR-CL2B-K4-1200-LD

##### F3S-TGR-CL4\_-K\_ (Type 4)

Number of optical axes	Sensing distance	Beam pitch	Feature set*1	Order code
2	0.5 m ... 40 m	500	Advanced	F3S-TGR-CL4A-K2-500
2	0.5 m ... 40 m	500	Basic	F3S-TGR-CL4B-K2-500
3	0.5 m ... 40 m	400	Advanced	F3S-TGR-CL4A-K3-800
3	0.5 m ... 40 m	400	Basic	F3S-TGR-CL4B-K3-800
4	0.5 m ... 40 m	300	Advanced	F3S-TGR-CL4A-K4-900
4	0.5 m ... 40 m	300	Basic	F3S-TGR-CL4B-K4-900
4	0.5 m ... 40 m	400	Advanced	F3S-TGR-CL4A-K4-1200
4	0.5 m ... 40 m	400	Basic	F3S-TGR-CL4B-K4-1200
2	25 m ... 50 m	500	Advanced	F3S-TGR-CL4A-K2-500-LD
2	25 m ... 50 m	500	Basic	F3S-TGR-CL4B-K2-500-LD
3	25 m ... 50 m	400	Advanced	F3S-TGR-CL4A-K3-800-LD
3	25 m ... 50 m	400	Basic	F3S-TGR-CL4B-K3-800-LD
4	25 m ... 50 m	300	Advanced	F3S-TGR-CL4A-K4-900-LD
4	25 m ... 50 m	300	Basic	F3S-TGR-CL4B-K4-900-LD
4	25 m ... 50 m	400	Advanced	F3S-TGR-CL4A-K4-1200-LD
4	25 m ... 50 m	400	Basic	F3S-TGR-CL4B-K4-1200-LD

#### Short-range active/passive systems

##### F3S-TGR-CL2\_-K\_C (Type 2)

Number of optical axes	Sensing distance	Beam pitch	Feature set*1	Order code
2	0.5 m ... 12 m	500	Advanced	F3S-TGR-CL2A-K2C-500
2	0.5 m ... 12 m	500	Basic	F3S-TGR-CL2B-K2C-500
3	0.5 m ... 8 m	400	Advanced	F3S-TGR-CL2A-K3C-800
3	0.5 m ... 8 m	400	Basic	F3S-TGR-CL2B-K3C-800
4	0.5 m ... 7 m	300	Advanced	F3S-TGR-CL2A-K4C-900
4	0.5 m ... 7 m	300	Basic	F3S-TGR-CL2B-K4C-900
4	0.5 m ... 7 m	400	Advanced	F3S-TGR-CL2A-K4C-1200
4	0.5 m ... 7 m	400	Basic	F3S-TGR-CL2B-K4C-1200

##### F3S-TGR-CL4\_-K\_C (Type 4)

Number of optical axes	Sensing distance	Beam pitch	Feature set*1	Order code
2	0.5 m ... 12 m	500	Advanced	F3S-TGR-CL4A-K2C-500
2	0.5 m ... 12 m	500	Basic	F3S-TGR-CL4B-K2C-500
3	0.5 m ... 8 m	400	Advanced	F3S-TGR-CL4A-K3C-800
3	0.5 m ... 8 m	400	Basic	F3S-TGR-CL4B-K3C-800
4	0.5 m ... 7 m	300	Advanced	F3S-TGR-CL4A-K4C-900
4	0.5 m ... 7 m	300	Basic	F3S-TGR-CL4B-K4C-900
4	0.5 m ... 7 m	400	Advanced	F3S-TGR-CL4A-K4C-1200
4	0.5 m ... 7 m	400	Basic	F3S-TGR-CL4B-K4C-1200

\*1. Feature set: Basic: Manual/automatic restart, coding  
Advanced: Basic + Muting + Pre-reset

### Ordering information finger- and hand protection safety sensor

Safety category	Feature set*2	Resolution	Length	Order code
2	Basic	14 mm	150 mm...2400 mm	F3S-TGR-CL2B-014-
		35 mm		F3S-TGR-CL2B-035-
	Advanced	14 mm		F3S-TGR-CL2A-014-
		35 mm		F3S-TGR-CL2A-035-
4	Basic	14 mm	150 mm...2400 mm	F3S-TGR-CL4B-014-
		35 mm		F3S-TGR-CL4B-035-
	Advanced	14 mm		F3S-TGR-CL4A-014-
		35 mm		F3S-TGR-CL4A-035-

\*2. Feature set: Basic: Manual/automatic restart, coding  
Advanced: Blanking functions + Muting + Pre-reset

### Specifications

#### Multi-beam safety sensor

Item	F3S-TGR-CL2_-K_	F3S-TGR-CL4_-K_
Sensor Type	Type 2	Type 4
Operating range	F3S-TGR-CL_-K_-LD: 0.5 m ... 40 m F3S-TGR-CL_-K_-LD: 25 m ... 50 m F3S-TGR-CL_-K2C-500: 0.5 m ... 12 m F3S-TGR-CL_-K3C-800: 0.5 m ... 8 m F3S-TGR-CL_-K4C-900: 0.5 m ... 7 m	
Beam pitch	F3S-TGR-CL_-K2_-500: 2 beams, 500 mm F3S-TGR-CL_-K3_-800: 3 beams, 400 mm F3S-TGR-CL_-K4_-900: 4 beams, 300 mm F3S-TGR-CL_-K4_-1200: 4 beams, 400 mm	
Effective aperture angle acc. EN 61496-2 (2006) for distances <3 m	Within ±5°	Within ±2.5°
Light source	Infrared LED (880 nm), Power dissipation <3 mW, Class 1 per EN 60825-1	
Supply Voltage	24 VDC±20%, according EN/IEC60204 able to cover a drop of voltage of at least 20 ms	
OSSD	2 PNP transistor outputs, load current 2x250 mA max	
Test functions	Self test (after power ON and during operation)	
Safety-related functions	All versions: Auto reset/ interlock with manual reset, EDM (external device monitoring) Advance version only: Muting and Pre-reset function	
Response time	< 13 ms	
Ambient temperature	Operating: -10°C...+55°C, Storage: -25°C...+70°C (no icing, no condensation)	
Degree of protection	IP 65 (IEC 60529)	
Materials	Case: Painted Aluminium, Front window: Acrylic Lexan, Cap: ABS, mounting brackets: cold rolled steel	
Size (cross section)	37x48 mm	
Suitable for safety control systems	Cat. 2 (EN954-1), PL c (EN ISO 13849-1)	Cat. 4 (EN954-1), PL e (EN ISO 13849-1)
MTTFd, DC	MTTFd = 450 years, DC = high, MTTR = 8 hours	
PFH, Proof test interval	PFHd = 2,5*10 <sup>-9</sup> , Proof test interval: every 20 years	

#### Finger- and hand safety protection sensor

Item	F3S-TGR-CL2_-0_	F3S-TGR-CL4_-0_
Sensor Type	Type 2	Type 4
Operating range: short setting	F3S-TGR-CL_-014: 0.2 m... 3 m; F3S-TGR-CL_-035: 0.2 m... 7 m	
Operating range: long setting	F3S-TGR-CL_-014: 3 m... 6 m; F3S-TGR-CL_-035: 7 m...14 m	
Beam pitch (center)	14 mm resolution: 7.5 mm 35 mm resolution: 18 mm	
Detection capability	14 mm resolution: 14 mm non-transparent 35 mm resolution: 35 mm non-transparent	
Effective aperture angle acc. EN 61496-2 (2006) for distances < 3 m	Within ±5°	Within ±2.5°
Light source	Infrared LED (880 nm), Power dissipation <3 mW, Class 1 per EN 60825-1	
Supply Voltage	24 VDC±20%, according EN/IEC60204 able to cover a drop of voltage of at least 20 ms	
OSSD	2 PNP transistor outputs, load current 2x250 mA max	
Test functions	Self test (after power ON and during operation)	
Safety-related functions	All versions: Auto reset/ interlock with manual reset, EDM (external device monitoring) Advance version only: Blanking, Muting and Pre-reset function	
Response time	ON to OFF: 14 ms...103 ms	
Ambient temperature	Operating: -10°C...+55°C, Storage: -25°C...+70°C (no icing, no condensation)	
Degree of protection	IP 65 (IEC 60529)	
Materials	Case: Painted Aluminium, Front window: Acrylic Lexan, Cap: ABS, mounting brackets: cold rolled steel	
Size (cross section)	37x48 mm	
Suitable for safety control systems	Cat. 2 (EN954-1), PL c (EN ISO 13849-1)	Cat. 4 (EN954-1), PL e (EN ISO 13849-1)
MTTFd, DC	MTTFd = 450 years, DC = high, MTTR = 8 hours	
PFH, Proof test interval	PFHd = 2,5*10 <sup>-9</sup> , Proof test interval: every 20 years	

F3S-TGR-CL and GSB-301-D in manual reset

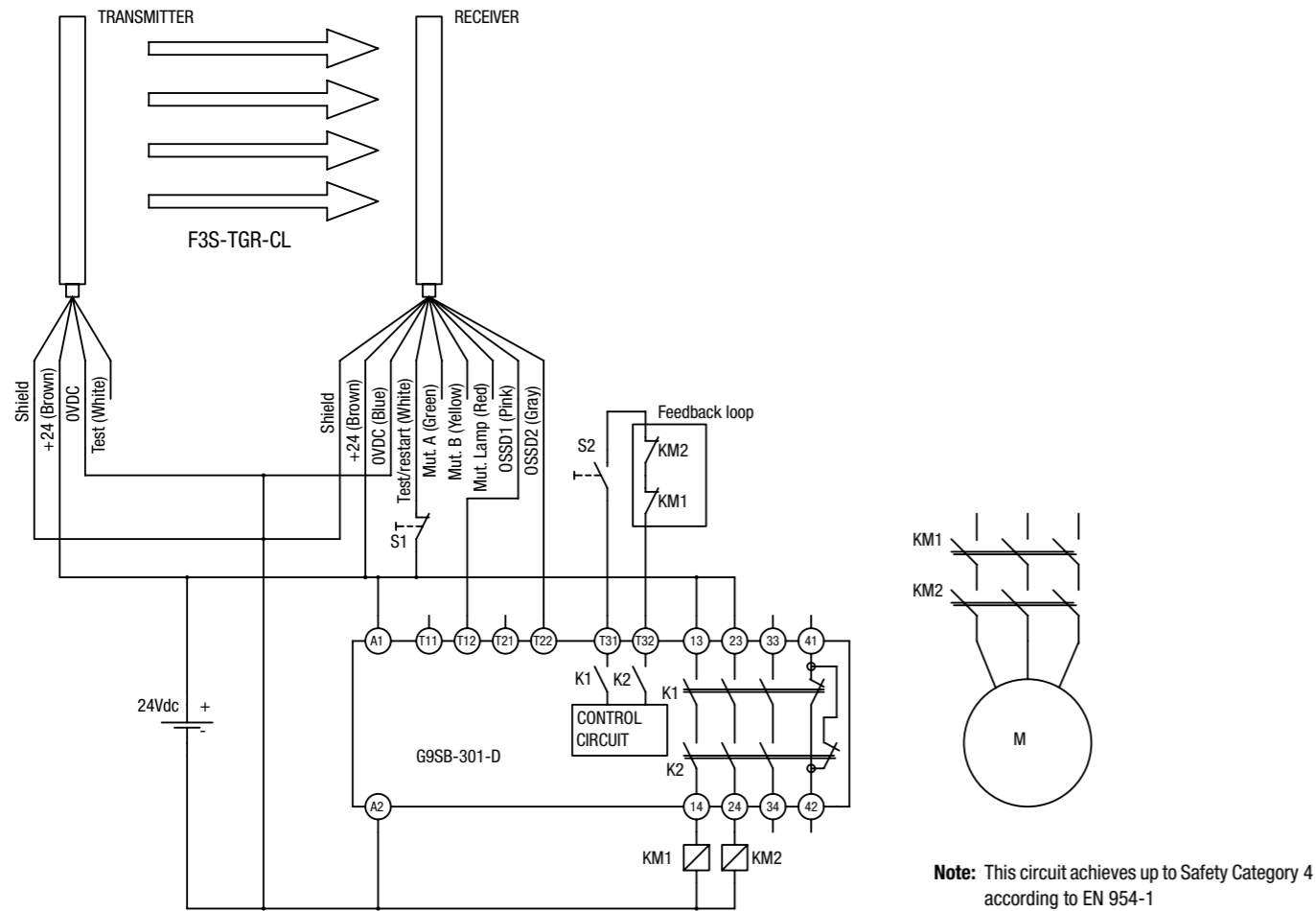

Standard cables

Receiver Cables (M12-8pin, shielded, flying leads)	
F39-TGR-CVL-B-2-R	Receiver Cable, 2 m length
F39-TGR-CVL-B-5-R	Receiver Cable, 5 m length
F39-TGR-CVL-B-10-R	Receiver Cable, 10 m length
F39-TGR-CVL-B-15-R	Receiver Cable, 15 m length
F39-TGR-CVL-B-25-R	Receiver Cable, 25 m length
Transmitter Cables (M12-4pin, shielded, flying leads)	
F39-TGR-CVL-B-2-E	Transmitter Cable, 2 m length
F39-TGR-CVL-B-5-E	Transmitter Cable, 5 m length
F39-TGR-CVL-B-10-E	Transmitter Cable, 10 m length
F39-TGR-CVL-B-15-E	Transmitter Cable, 15 m length
F39-TGR-CVL-B-25-E	Transmitter Cable, 25 m length

Mounting bracket F39-TGR-ST-ADJ

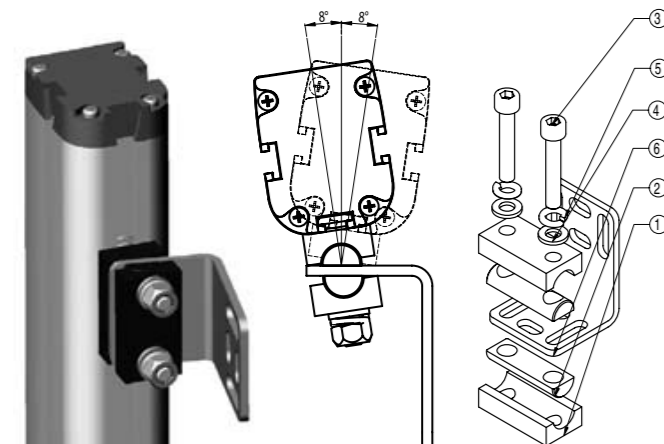

Wiring accessories (connectors and Y-connector cables)

Type	
F39-TGR-CT-B-R	Connector M12, 8-pin, female for wiring
F39-TGR-CT-B-E	Connector M12, 4-pin, female for wiring
F39-TGR-CT-W-R	Connector M12, 8-pin, male for wiring
F39-TGR-CT-W-E	Connector M12, 4-pin, male for wiring
F39-TGR-CVL-D-B-5-R	Cable for Sensor system and muting lamp connection

Safety relay units

Family	Type Name	Configuration	
G9SB	G9SB-200-D	DPST-NO	
	G9SB-301-D	3PST-NO	
	G9SA	G9SA-301	3PST-NO
		G9SA-501	5PST-NO
G9SA-321-T075		3PST-NO, Time del. 7.5 s	
	G9SA-321-T15	3PST-NO, Time del. 15 s	
	G9SA-321-T30	3PST-NO, Time del. 30 s	
G9SX	G9SX-BC202-RT	2 Safe Outputs	
	G9SX-BC202-RC	2 Safe Outputs	
	G9SX-AD322-T15-RT	3 Safe Outputs, Time del. 15 s	
	G9SX-AD322-T15-RC	3 Safe Outputs, Time del. 15 s	
	G9SX-AD322-T150-RT	3 Safe Outputs, Time del. 150 s	
	G9SX-AD322-T150-RC	3 Safe Outputs, Time del. 150 s	
	G9SX-ADA222-T15-RT	2 Safe Outputs, Time del. 15 s	
	G9SX-ADA222-T15-RC	2 Safe Outputs, Time del. 15 s	
	G9SX-ADA222-T150-RT	2 Safe Outputs, Time del. 150 s	
	G9SX-ADA222-T150-RC	2 Safe Outputs, Time del. 150 s	
	DeviceNet Safety	NE1A-SCPU01	16 In, 8 Out, Safety Master
		NE1A-SCPU02	40 In, 8 Out, Safety Master
	Safety Controller	NE1A-SCPU01L	16 In, 8 Out
		NE1A-SCPU02L	40 In, 8 Out
Relay interface	F39-TGR-SB-R	Relay interface for Semiconductor OSSDs	

Dimensions

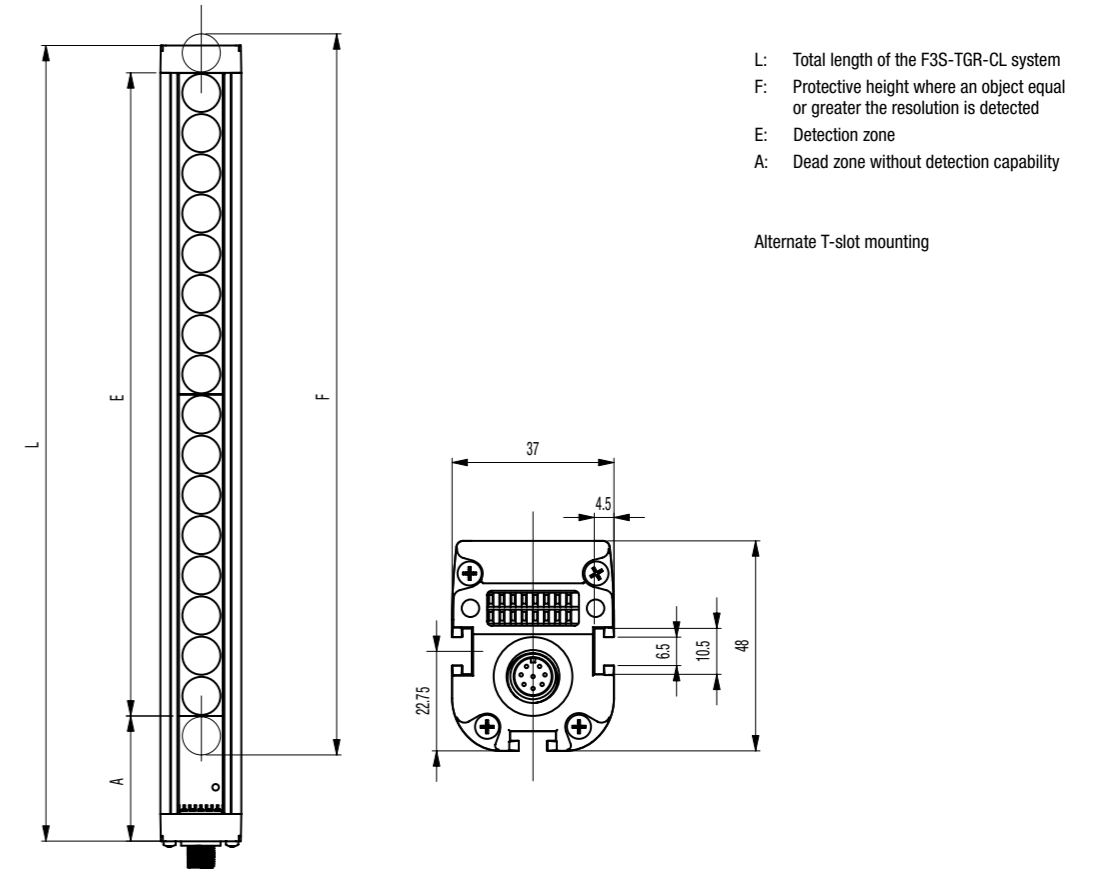

F3S-TGR-CL system data with 14 mm resolution

	150 mm	300 mm	450 mm	600 mm	750 mm	900 mm	1050 mm	1200 mm	1350 mm	1500 mm	1650 mm	1800 mm	1950 mm	2100 mm	2250 mm	2400 mm
L [mm]	217	364	511	658	805	952	1099	1246	1393	1540	1687	1834	1981	2128	2275	2422
F [mm]	161	308	455	602	749	896	1043	1190	1337	1484	1631	1778	1925	2072	2219	2366
E [mm]	147	294	441	588	735	882	1029	1176	1323	1470	1617	1764	1911	2058	2205	2352
A [mm]	59	59	59	59	59	59	59	59	59	59	59	59	59	59	59	59
Weight [kg]	0.83 kg	1.39 kg	1.95 kg	2.51 kg	3.07 kg	3.63 kg	4.19 kg	4.75 kg	5.31 kg	5.87 kg	6.43 kg	7 kg	7.55 kg	8.11 kg	8.67 kg	9.24 kg

F3S-TGR-CL system data with 35 mm resolution

	150 mm	300 mm	450 mm	600 mm	750 mm	900 mm	1050 mm	1200 mm	1350 mm	1500 mm	1650 mm	1800 mm	1950 mm	2100 mm	2250 mm	2400 mm
L [mm]	217	364	511	658	805	952	1099	1246	1393	1540	1687	1834	1981	2128	2275	2422
F [mm]	182	329	476	623	770	917	1064	1211	1358	1505	1652	1799	1946	2093	2240	2387
E [mm]	147	294	441	588	735	882	1029	1176	1323	1470	1617	1764	1911	2058	2205	2352
A [mm]	59	59	59	59	59	59	59	59	59	59	59	59	59	59	59	59
Weight [kg]	0.83 kg	1.39 kg	1.95 kg	2.51 kg	3.07 kg	3.63 kg	4.19 kg	4.75 kg	5.31 kg	5.87 kg	6.43 kg	7 kg	7.55 kg	8.11 kg	8.67 kg	9.24 kg

F3S-TGR-CL-K system data

Model number	Weight	Dimensions			
		F [mm]	L [mm]	E [mm]	A [mm]
F3S-TGR-CL-K2C-500	2.3 kg	518	682	500	59
F3S-TGR-CL-K3C-800	3.2 kg	818	982	400	59
F3S-TGR-CL-K4C-900	4.1 kg	918	1082	300	59
F3S-TGR-CL-K4C-1200	4.9 kg	1218	1382	400	59
F3S-TGR-CL-K2-500	2.3 kg	518	682	500	59
F3S-TGR-CL-K3-800	3.2 kg	818	982	400	59
F3S-TGR-CL-K4-900	4.1 kg	918	1082	300	59
F3S-TGR-CL-K4-1200	4.9 kg	1218	1382	400	59
F3S-TGR-CL-K2-500-LD	2.3 kg	518	682	500	59
F3S-TGR-CL-K3-800-LD	3.2 kg	818	982	400	59
F3S-TGR-CL-K4-900-LD	4.1 kg	918	1082	300	59
F3S-TGR-CL-K4-1200-LD	4.9 kg	1218	1382	400	59



**OMRON EUROPE B.V.** Wegalaan 67-69, NL-2132 JD, Hoofddorp, The Netherlands. Tel: +31 (0) 23 568 13 00 Fax: +31 (0) 23 568 13 88 [www.industrial.omron.eu](http://www.industrial.omron.eu)

**Austria**

Tel: +43 (0) 2236 377 800  
[www.industrial.omron.at](http://www.industrial.omron.at)

**Belgium**

Tel: +32 (0) 2 466 24 80  
[www.industrial.omron.be](http://www.industrial.omron.be)

**Czech Republic**

Tel: +420 234 602 602  
[www.industrial.omron.cz](http://www.industrial.omron.cz)

**Denmark**

Tel: +45 43 44 00 11  
[www.industrial.omron.dk](http://www.industrial.omron.dk)

**Finland**

Tel: +358 (0) 207 464 200  
[www.industrial.omron.fi](http://www.industrial.omron.fi)

**France**

Tel: +33 (0) 1 56 63 70 00  
[www.industrial.omron.fr](http://www.industrial.omron.fr)

**Germany**

Tel: +49 (0) 2173 680 00  
[www.industrial.omron.de](http://www.industrial.omron.de)

**Hungary**

Tel: +36 1 399 30 50  
[www.industrial.omron.hu](http://www.industrial.omron.hu)

**Italy**

Tel: +39 02 326 81  
[www.industrial.omron.it](http://www.industrial.omron.it)

**Netherlands**

Tel: +31 (0) 23 568 11 00  
[www.industrial.omron.nl](http://www.industrial.omron.nl)

**Norway**

Tel: +47 (0) 22 65 75 00  
[www.industrial.omron.no](http://www.industrial.omron.no)

**Poland**

Tel: +48 (0) 22 645 78 60  
[www.industrial.omron.pl](http://www.industrial.omron.pl)

**Portugal**

Tel: +351 21 942 94 00  
[www.industrial.omron.pt](http://www.industrial.omron.pt)

**Russia**

Tel: +7 495 648 94 50  
[www.industrial.omron.ru](http://www.industrial.omron.ru)

**South-Africa**

Tel: +27 (0)11 579 2600  
[www.industrial.omron.co.za](http://www.industrial.omron.co.za)

**Spain**

Tel: +34 913 777 900  
[www.industrial.omron.es](http://www.industrial.omron.es)

**Sweden**

Tel: +46 (0) 8 632 35 00  
[www.industrial.omron.se](http://www.industrial.omron.se)

**Switzerland**

Tel: +41 (0) 41 748 13 13  
[www.industrial.omron.ch](http://www.industrial.omron.ch)

**Turkey**

Tel: +90 216 474 00 40  
[www.industrial.omron.com.tr](http://www.industrial.omron.com.tr)

**United Kingdom**

Tel: +44 (0) 870 752 08 61  
[www.industrial.omron.co.uk](http://www.industrial.omron.co.uk)

**More Omron representatives**  
[www.industrial.omron.eu](http://www.industrial.omron.eu)

*Authorised Distributor:*

**Control Systems**

• Programmable logic controllers • Human-machine interfaces • Remote I/O

**Motion & Drives**

• Motion controllers • Servo systems • Inverters

**Control Components**

• Temperature controllers • Power supplies • Timers • Counters • Programmable relays  
• Digital panel indicators • Electromechanical relays • Monitoring products • Solid-state relays  
• Limit switches • Pushbutton switches • Low voltage switch gear

**Sensing & Safety**

• Photoelectric sensors • Inductive sensors • Capacitive & pressure sensors  
• Cable connectors • Displacement & width-measuring sensors • Vision systems  
• Safety networks • Safety sensors • Safety units/relay units • Safety door/guard lock switches