

ASBSM.../LED

Steckbarer Miniatur-Aktor-/ Sensor-Verteiler mit LED-Betriebs- und Funktionsanzeige, 4- bis 10-fach, M8-Buchse, 3-polig, 1 Signal pro Buchse, M12-Steckverbindung für die Zuleitung (Typ: RKT 12-348/...M)

Pluggable miniature actuator/ sensor distribution box with LED operation and function indicators, 4-10 ports, M8 socket, 3 poles, 1 signal per socket, M12 connection for the control cable (type: RKT 12-348/...M)

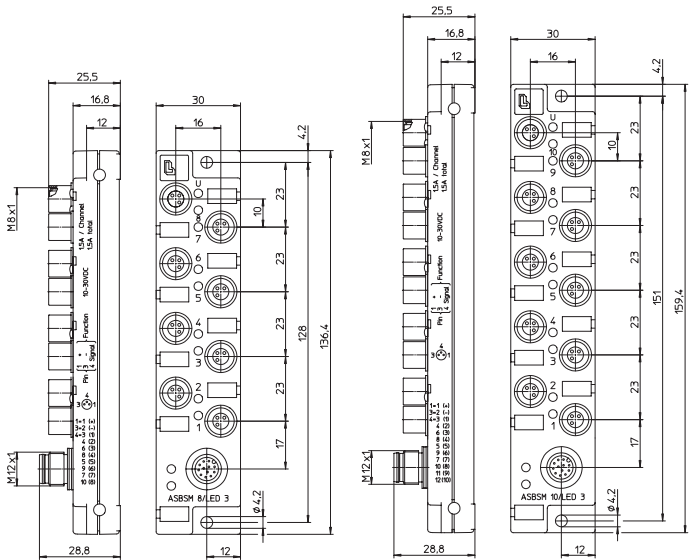
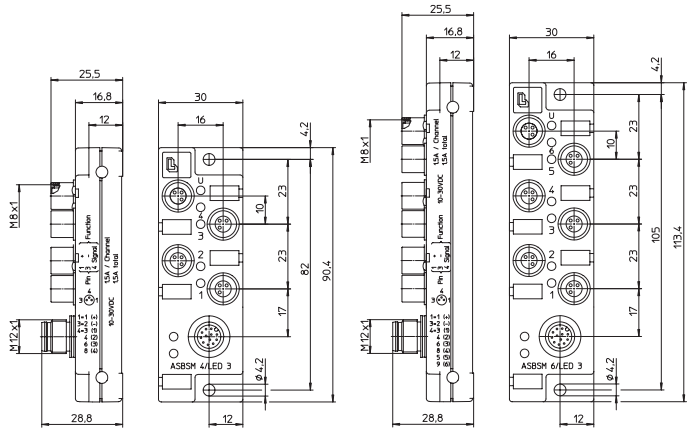

Pinbelegung / Schaltbild
Pin assignment / wiring diagram

4-fach
4 ports

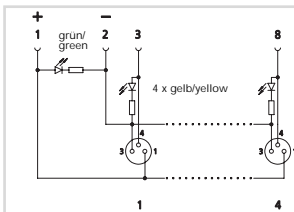

- 1 = 1 (+)
- 3 = 2 (-)
- 4 = 3 (1)
- 4 = 2 (2)
- 6 = 3 (3)
- 8 = 4 (4)

6-fach
6 ports

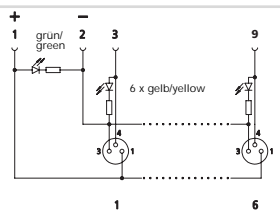

- 1 = 1 (+)
- 3 = 2 (-)
- 4 = 3 (1)
- 4 = 2 (2)
- 6 = 3 (3)
- 8 = 4 (4)
- 8 = 5 (5)
- 9 = 6 (6)

8-fach
8 ports

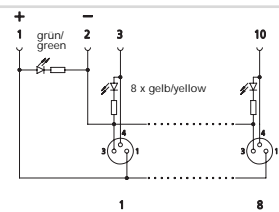

- 1 = 1 (+)
- 3 = 2 (-)
- 4 = 3 (1)
- 4 = 2 (2)
- 6 = 3 (3)
- 8 = 4 (4)
- 8 = 5 (5)
- 9 = 6 (6)
- 7 = 7 (7)
- 10 = 8 (8)

10-fach
10 ports

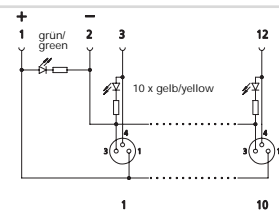



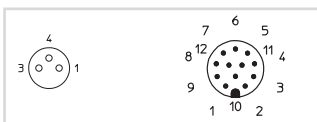









- 1 = 1 (+)
- 3 = 2 (-)
- 4 = 3 (1)
- 4 = 2 (2)
- 6 = 3 (3)
- 8 = 4 (4)
- 8 = 5 (5)
- 9 = 6 (6)
- 7 = 7 (7)
- 10 = 8 (8)
- 11 = 9 (9)
- 12 = 10 (10)



Technische Daten	
Umgebungstemperatur	-25°C / +70°C
Werkstoffe	
Gehäuse	PBT
Kontaktträger	PA, selbstverlöschend
Kontakt M8	CuSn, unternickelt und 0,8 µm vergoldet
Kontakt M12	CuZn, unternickelt und 0,8 µm vergoldet
Gewindebuchse	CuZn, vernickelt
O-Ring	FKM
Mechanische Daten	
Schutzart	IP 67 Nur im verschraubten Zustand mit den dazugehörigen Gegenstücken oder Schutzkappen.
Elektrische Daten	
Durchgangswiderstand	≤ 5 m Ω
Nennstrom bei 40°C	1,5 A pro Steckplatz / 1,5 A max. gesamt
Nennspannung	10–30 V DC
Isolationswiderstand	> 10 ⁹ Ω
Verschmutzungsgrad	3
Zubehör (inkl.)	
ZVKM	2 M8-Schutzkappen für nicht belegte Kupplungsgehäuse
ZBR 5/10	Beschriftungsschilder: 4-fach: 5 Stück 6- bis 8-fach: 10 Stück 10-fach: 15 Stück

Technical data	
Operating temperature range	-25°C / +70°C
Materials	
Housing	PBT
Insert	PA, self-extinguishing
Contact M8	CuSn, pre-nickelated and 0.8 microns gold-plated
Contact M12	CuZn, pre-nickelated and 0.8 microns gold-plated
Receptacle shell	CuZn, nickel-plated
O-ring	FKM
Mechanical data	
Degree of protection	IP 67 Only in locked position with its proper counterparts or dust covers.
Electrical data	
Contact resistance	≤ 5 m Ω
Nominal current at 40°C	1.5 A per outlet / 1.5 A max. total
Nominal voltage	10–30 V DC
Insulation resistance	> 10 ⁹ Ω
Pollution degree	3
Accessories (incl.)	
ZVKM	2 M8 dust covers for unused sockets
ZBR 5/10	attachable labels: 4 ports: 5 pieces 6–8 ports: 10 pieces 10 ports: 15 pieces

Bestellbezeichnung Designation	Ausführung Version	
ASBSM 4/LED 3	4-fach / 4 ports	  
ASBSM 6/LED 3	6-fach / 6 ports	  
ASBSM 8/LED 3	8-fach / 8 ports	  
ASBSM 10/LED 3	10-fach / 10 ports	  

Ein Einsatz der Produkte in aggressiven Medien ist im Einzelfall zu überprüfen.

The application of these products in harsh environments should always be checked before use.